

Article number: 2310305473ESD

Description: E+G Antistatic base for levelling elements  
LV.A-100-14-M12x68-ESD-C

## Measures

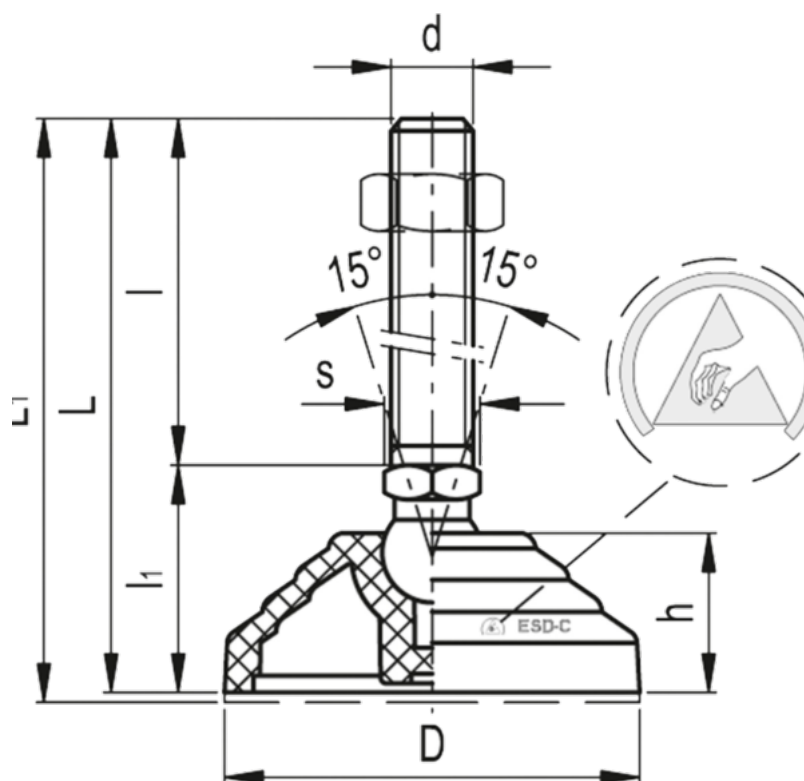

Articulation = 14  
D = 100  
d = M12  
h = 24  
l = -  
l1 = -  
L = 101  
Max load = 18000

s = 14  
Weight in (g) = 127